



antoniolupi

PIATTI E BOX DOCCIA
TRAYS AND SHOWER ENCLOSURES





PIATTE BOX DOCCIA
SHOWER ENCLOSURES

BILICO



vetro extrachiaro
extra-clear glass



PIATTE BOX DOCCIA
SHOWER ENCLOSURES

BILICO



vetro extrachiaro
extra-clear glass



PIATTE BOX DOCCIA
SHOWER ENCLOSURES

vetro riflettente fumé
reflective fumé glass



art.

BILICO1N

da / a - from / to

H	L
198,3	67 / 77
	78 / 90

Box doccia dx o sx in vetro temperato spess. 8 mm per piatti doccia SUMISURA, ZEROMATT, 00_XL e 00_ST tra pareti in nicchia, completo di perno e barra di sostegno.

Right or left shower enclosure in 8 mm tempered glass for shower tray SUMISURA, ZEROMATT, 00_XL and 00_ST within a recessed area, complete with pin and supporting bar.

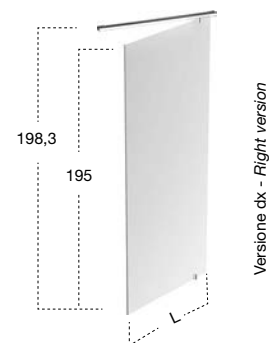

- Rivestimento.
- Tile Coating.

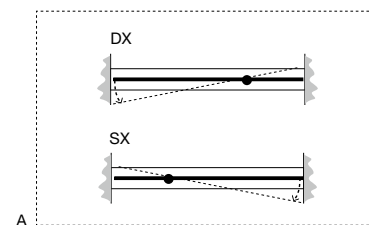
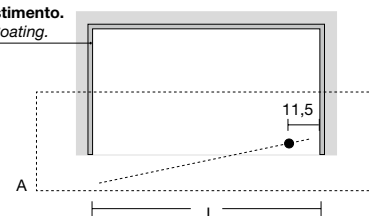

art.

BILICO5N

da / a - from / to

H	L
198,3	117 / 137

Box doccia dx o sx in vetro temperato spess. 8 mm per piatti doccia SUMISURA, ZEROMATT, 00_XL e 00_ST tra pareti in nicchia, completo di perno centrale e barra di sostegno.

Right or left shower enclosure in 8 mm tempered glass for shower tray SUMISURA, ZEROMATT, 00_XL and 00_ST within a recessed area, complete with center pin and supporting bar.

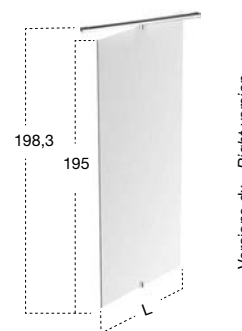

- Rivestimento.
- Tile Coating.

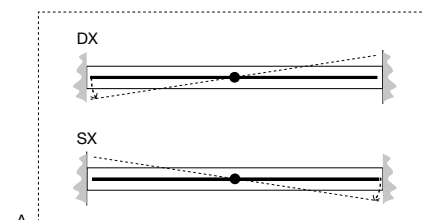
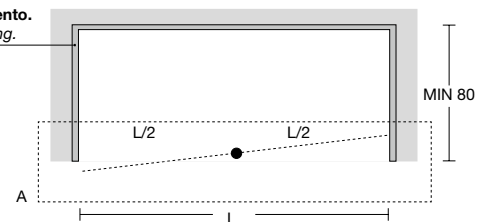

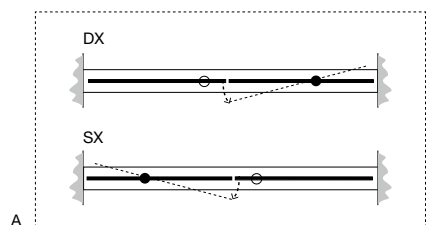
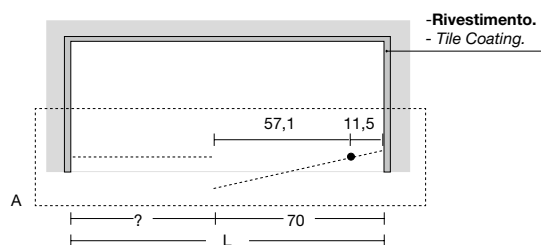
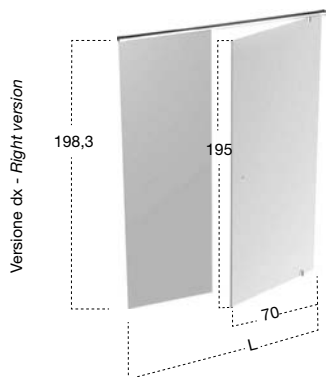

art.

BILICO3N	
	da / a - from / to
H	L
198,3	91 / 117
	118 / 137
	138 / 157
	158 / 177
	178 / 197

Box doccia dx o sx in vetro temperato spess. 8 mm per piatti doccia SUMISURA, ZEROMATT, 00_XL e 00_ST tra pareti in nicchia, completo di perno, barra di sostegno e profilo a parete in acciaio inox satinato AISI 304.

Right or left shower enclosure in 8 mm tempered glass for shower tray SUMISURA, ZEROMATT, 00_XL and 00_ST within a recessed area, complete with pin, supporting bar and satin stainless steel wall profile AISI 304.

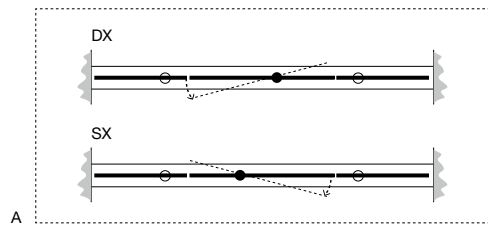
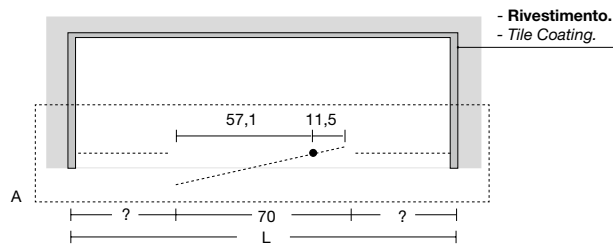
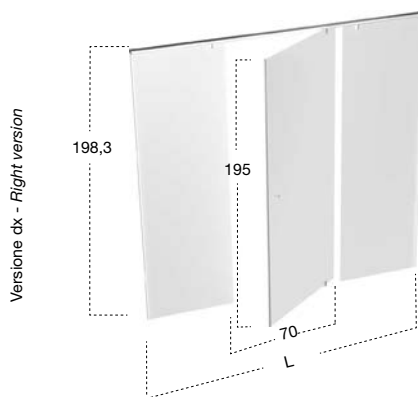

art.

BILICO7N	
	da / a - from / to
H	L
198,3	157 / 177
	178 / 197

Box doccia dx o sx in vetro temperato spess. 8 mm per piatti doccia SUMISURA, ZEROMATT, 00_XL e 00_ST tra pareti in nicchia, completo di perno, barra di sostegno e profili a parete in acciaio inox satinato AISI 304.

Right or left shower enclosure in 8 mm tempered glass for shower tray SUMISURA, ZEROMATT, 00_XL and 00_ST within a recessed area, complete with pin, supporting bar and wall profiles in satin stainless steel AISI 304.

art.	P
BILICO80AL	67 / 77
BILICO90AL	78 / 90
	da / a - from / to
P	L
67 / 77	89 / 119
	120 / 139
78 / 90	89 / 119
	120 / 139

Box doccia dx o sx in vetro temperato spess. 8 mm per piatti doccia SUMISURA, ZEROMATT, 00_XL e 00_ST tra pareti in nicchia, completo di perno e barra di sostegno.

Right or left shower enclosure in 8 mm tempered glass for shower tray SUMISURA, ZEROMATT, 00_XL and 00_ST within a recessed area, complete with pin and supporting bar.

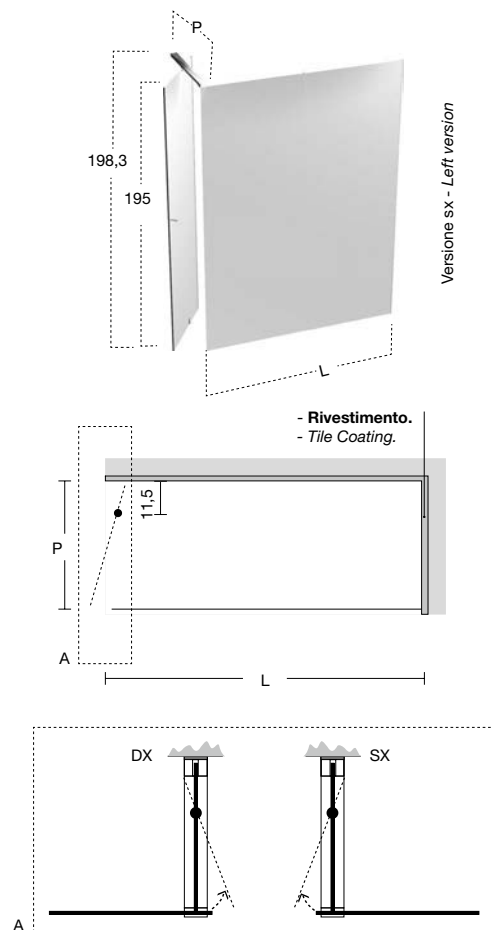

PIATTE BOX DOCCIA
SHOWER ENCLOSURES

art.	P
BILICO80AF	67 / 77
BILICO90AF	78 / 90
	da / a - from / to
P	L
67 / 77	89 / 119
	120 / 139
	140 / 159
	160 / 179
	180 / 199
78 / 90	89 / 119
	120 / 139
	140 / 159
	160 / 179
	180 / 199

Box doccia dx o sx in vetro temperato spess. 8 mm per piatti doccia SUMISURA, ZEROMATT, 00_XL e 00_ST tra pareti in angolo, completo di perno, barra di sostegno e profili a parete in acciaio inox satinato AISI 304.

Right or left shower enclosure in 8 mm tempered glass for shower tray SUMISURA, ZEROMATT, 00_XL and 00_ST within a corner, complete with pin, supporting bar and wall profiles in satin stainless steel AISI 304.

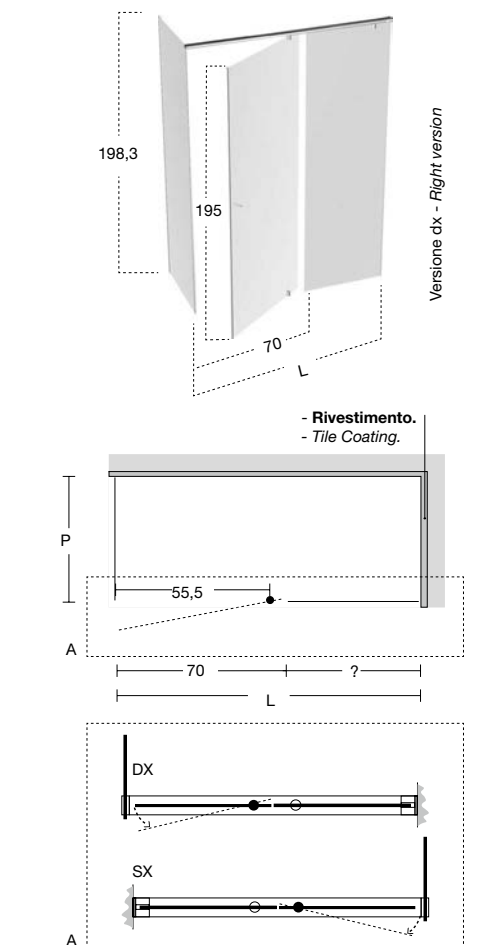

SUMISURA

_2017

design
Nevio
Tellatin

Sumisura è il piatto doccia sartoriale che esprime alla perfezione, anche nell'elemento apparentemente più semplice, la concezione dell'ambiente bagno contemporaneo di antoniolupi. Un ambiente bagno disegnato e progettato secondo le esigenze di ciascuno, un abito cucito addosso a chi lo vive, un modo di esprimere il proprio io nella stanza più intima della casa. Un pensiero e un modo d'essere che si traduce anche in un elemento tecnico come il piatto doccia. Sumisura è realizzato in Moodlight, il materiale nato dall'evoluzione del Flumood, brevettato da antoniolupi, che riesce a dar vita a superfici ancora più leggere, resistenti e performanti. Sumisura è disponibile in qualsiasi larghezza e profondità nello spessore di 2 cm. La tecnologia utilizzata permette di mantenere la pendenza costante su tutta la superficie mentre la libertà di posizionare lo scarico in punti diversi facilita le operazioni di posa, amplifica le possibilità di personalizzazione e la funzionalità del piatto doccia. Il disegno essenziale della piletta permette di completare un'estetica coordinata per uno stile essenziale e contemporaneo.

Sumisura is the tailor-made shower tray that expresses perfection, even in the seemingly simplest element, the concept of a contemporary antoniolupi bathroom. A bathroom designed according to the needs of each individual, a dress sewn on to those who live it, a way of expressing one's self in the most intimate room of the house. A thought and a way of being that also translates into a technical element like the shower tray. Sumisura is made in Moodlight, the material created from the evolution of Flumood, patented by antoniolupi, which manages to create even lighter, more durable and powerful surfaces. Sumisura is available in any width and depth in the thickness of 2 cm. The technology used keeps the steady slope across the surface while the freedom to place the drain at different points facilitates installation, all enhances the possibilities of customization and the functionality of the shower tray. The basic design of the drain completes the coordinated aesthetics allowing for an essential and contemporary style.

MOLTEPLICI PERSONALIZZAZIONI A RICHIESTA
MULTIPLE PERSONALIZATIONS ON REQUEST

Piatto doccia a misura in larghezza e profondità mantenendo la pendenza
Custom shower tray in length and depth while maintaining the slope

Pendenza costante su tutta la superficie
Constant slope across the surface

Resina anti UV e anti ingiallimento
Anti UV and anti yellowing resin

Posizionamento scarico variabile
Variable drain position

Possibilità di inserimento doppio scarico
Double drain available

Bordo rialzato
Raised edge

Tagli e realizzazioni fuori squadra
Cuts and out of square production

Personalizzazioni su dima e su disegno
Customizations on template and drawing

Fresatura per incasso vetro
Milling for glass insertion

Fresatura per installazione a semincasso
Milling for semi encased installation

Personalizzazione con inserimento del nome
Customized with name



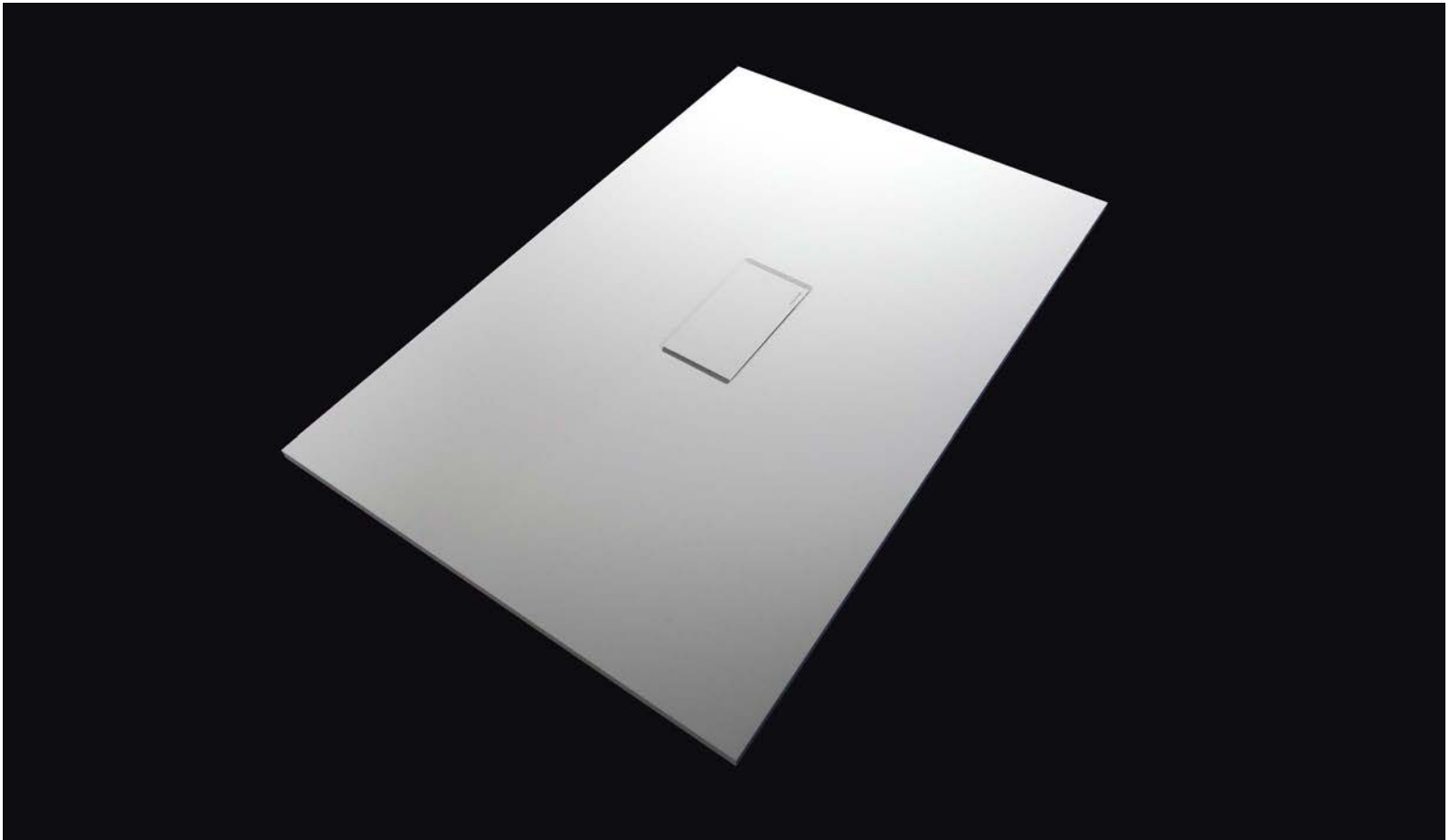

art.	P
SM_80	70 / 80
SM_90	81 / 90
SM_100	91 / 100
SM_110	101 / 110
SM_120	111 / 120



da incasso
encased



da appoggio
top mount

H	L
2	70 / 80
	81 / 90
	91 / 100
	101 / 110
	111 / 120
	121 / 130
	131 / 140
	141 / 150 **
	151 / 160 **
	161 / 170 **
	171 / 180 **
	181 / 190 **
	191 / 200 **
	201 / 210 **
	211 / 220 **

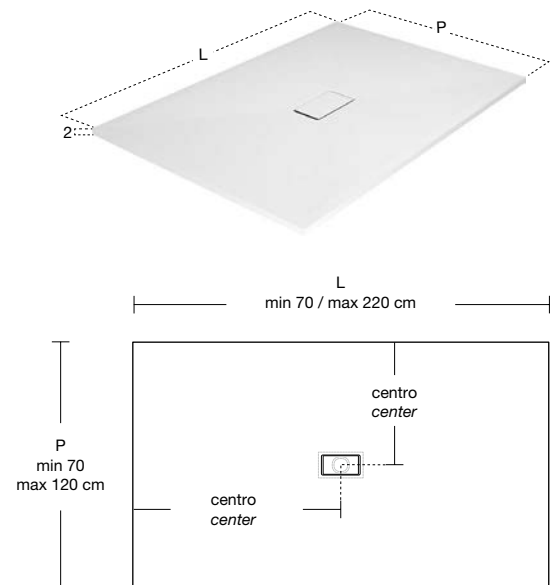

** N.B. Su richiesta è possibile inserire un secondo scarico completo di piletta sifonata.
P.S. Upon request it is possible to have a second drain complete with trap and plug.

Spess. 2 cm
Thickness 2 cm

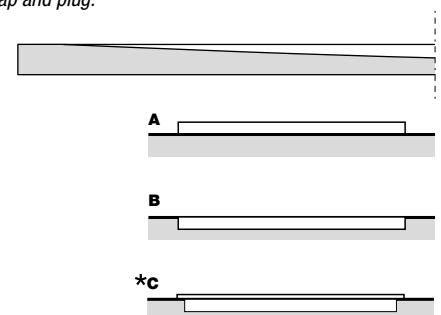

Piatto doccia rettangolare a misura da appoggio (A), da incasso (B) o da semincasso (*C) in Moodlight spess. 2 cm, completo di sifone e piletta con scarico libero posizionato al centro, con pendenza costante su tutta la superficie.

* N.B. Lavorazione su richiesta.

Rectangular top mount (A), encased (B) or semi encased (*C) shower tray in Moodlight 2 cm thick, complete with siphon and open centered drain, with a constant slope across the surface.

* P.S. Manufacturing upon request.

Per personalizzazioni diverse da quanto indicato si prega di consultare l'azienda / For customization other than that indicated please consult the company

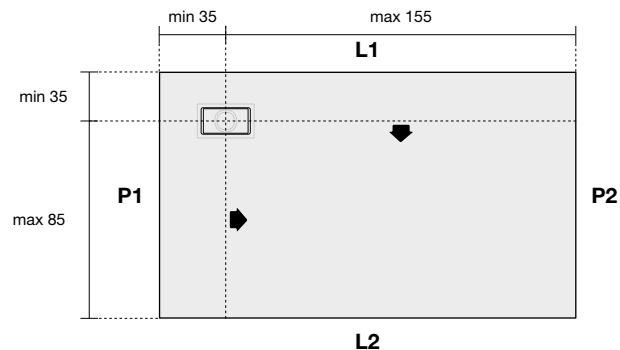

POSIZIONE SCARICO VARIABILE A RICHIESTA

La larghezza massima del piatto doccia è di L 220 cm, considerando che la massima estensione di pendenza dal centro piletta è di L 155 cm, è possibile posizionare lo scarico decentrato dove necessita, rispettando le misure minime e massime riportate nello schema.

DRAIN POSITION VARIABLE ON REQUEST

The maximum width of the shower tray is L 220 cm, considering the maximum slope from the center of the drain is L 155 cm, so the drain can be positioned where necessary, considering the minimum and maximum measurements reported in the diagram.

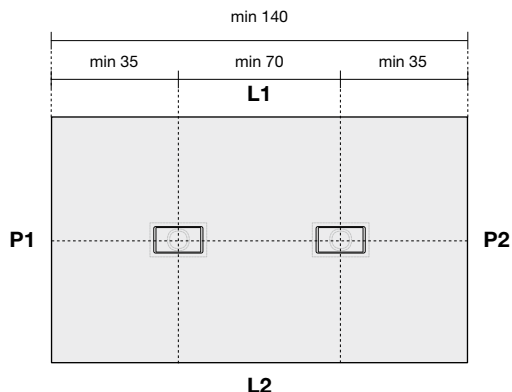

POSIZIONE DOPPIO SCARICO VARIABILE A RICHIESTA

Rispettando le misure minime in profondità (P1/P2) min 35 cm riportate nello schema precedente, è possibile posizionare in larghezza (L1/L2) sullo stesso asse un doppio scarico su un L min 140 cm.

VARIABLE POSITION OF DOUBLE DRAIN UPON REQUEST

It is possible to include a second drain on a minimum L 140 cm, considering the minimum measurements in depth P1/P2 min 35 cm shown in the diagram and in length L1/L2 along the same axis.



Per personalizzazioni diverse da quanto indicato si prega di consultare l'azienda / For customization other than that indicated please consult the company

PER OGNI PERSONALIZZAZIONE È NECESSARIO FORNIRE LA DIMA O UN DISEGNO DETTAGLIATO / FOR ANY CUSTOMIZATION YOU MUST PROVIDE THE COMPANY A TEMPLATE OR A DETAILED DRAWING:

È possibile realizzare fuori squadra, tagli, sagome su disegno (file DXF o DWG) o su dima.

It is possible to produce out of square, cuts, shapes with a drawing (file in DXF or DWG) or with template.

ESEMPI DI PERSONALIZZAZIONI / EXAMPLE OF CUSTOMIZATION:

SAGOMA QUADRATA / SQUARE SHAPE

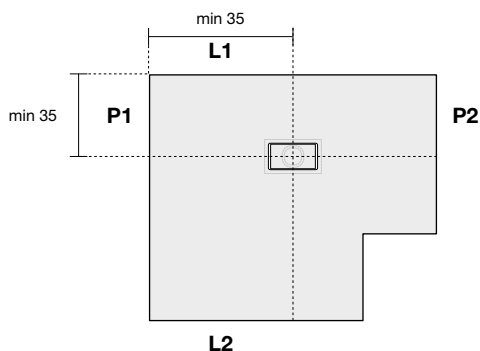

TAGLIO OBLIQUO / OBLIQUE CUTTING

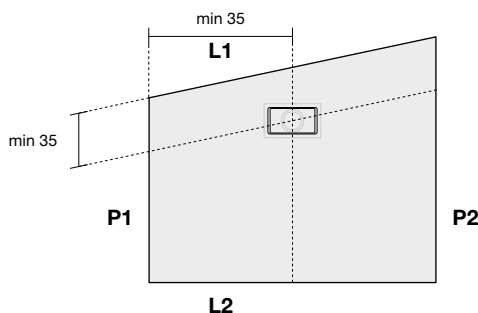

SAGOMA CURVA / CURVED TEMPLATE

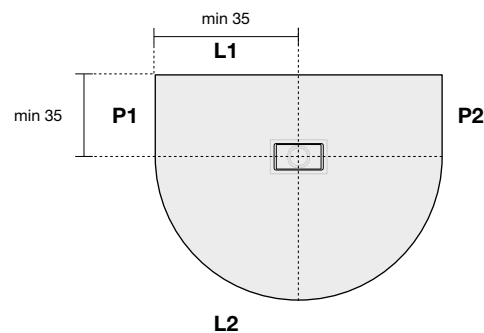

PIATTI BOX DOCCIA
SHOWER ENCLOSURES

È possibile realizzare lavorazioni personalizzate sui lati del piatto quali, fresature o bordi rialzati.

On request milling or raised edges can be produced.

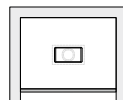

1 lato / 1 side

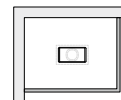

2 lati / 2 sides

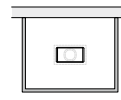

3 lati / 3 sides

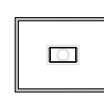

4 lati / 4 sides

ESEMPI DI LAVORAZIONI / EXAMPLES OF WORKMANSHIP:

FRESATURA PER INCASSO VETRO PER OGNI LATO

MILLING FOR GLASS INSERTION ON EACH SIDE

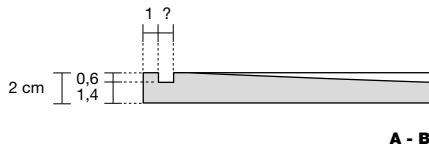

A - B

FRESATURA PER INSTALLAZIONE A SEMINCASSO PER OGNI LATO

MILLING FOR SEMI ENCASED INSTALLATION ON EACH SIDE

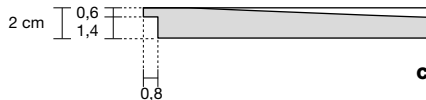

C

BORDO RIALZATO PER OGNI LATO

RAISED EDGE ON EACH SIDE

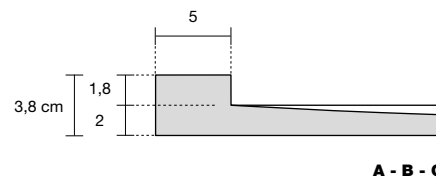

A - B - C

ESEMPI DI INSTALLAZIONE / EXAMPLES OF INSTALLATION:



APPOGGIO / TOP MOUNT

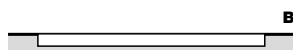

INCASSO / ENCASED

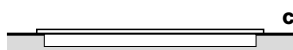

SEMINCASSO / SEMI ENCASED





PIATTE BOX DOCCIA
SHOWER ENCLOSURES



da incasso
encased



da appoggio
top mount

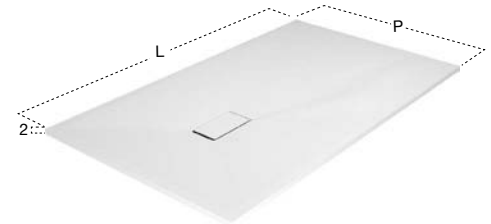

N.B. Per vetri - For shower enclosures.

Art. COMBI20 - Art. COMBI120 - Art. COMBI70 - Art. COMBI80
Art. COMBI90 - Art. COMBI170 - Art. COMBI180 - Art. COMBI190

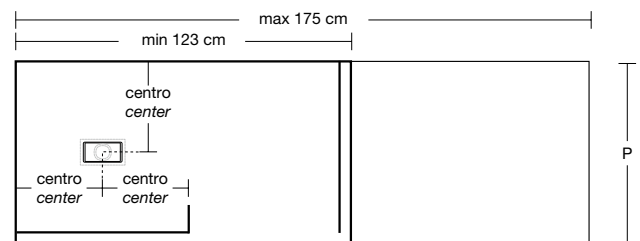

Versione dx - Right version

art.	P
SM_COMBI70	70
SM_COMBI80	80
SM_COMBI90	90
H	L
2	123
	136
	149
	162
	175

Piatto doccia rettangolare dx o sx da appoggio (A), da incasso (B) o da semincasso (*C) in Moodlight spess. 2 cm, completo di sifone e piletta con scarico libero.

* N.B. Lavorazione su richiesta.

Right or left rectangular top mount (A), encased (B) or semi encased (*C) shower tray in Moodlight 2 cm thick, complete with siphon and open drain.

* P.S. Manufacturing upon request.





vetro extrachiario
extra-clear glass

art.

COMBI1

Asta distanziale in acciaio inox satinato AISI 304, per fissaggio a parete vetri box doccia
Art. COMBI20 e Art. COMBI120.

Satin stainless steel AISI 304 shower bar for wall to glass shower cabin fitting Art. COMBI20 and Art. COMBI120.

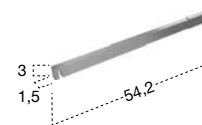

art. H

COMBI20 195

COMBI120 220

Per piatti doccia
For shower trays

P	L	L
20	66	123
	79	136
	92	149
	105	162
	118	175

Box doccia dx o sx in vetro temperato spess. 8 mm solo per piatti doccia Art. SM_COMBI tra pareti in nicchia, completo di profilo a parete.

Right or left shower enclosure in 8 mm tempered glass only for shower trays Art. SM_COMBI within a recessed area complete with wall profiles.

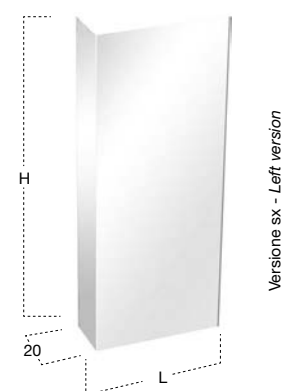

PIATTI BOX DOCCIA
SHOWER ENCLOSURES

art. H P

COMBI70 195 70

COMBI80 195 80

COMBI90 195 90

COMBI170 220 70

COMBI180 220 80

COMBI190 220 90

Per piatti doccia
For shower trays

P	L	P	L
67,5 / 77,5 / 87,5	120,5	70 / 80 / 90	123
	133,5		136
	146,5		149
	159,5		162
	172,5		175

Box doccia dx o sx in vetro temperato spess. 8 mm solo per piatti doccia Art. SM_COMBI tra pareti in angolo, completo di profili a parete e distanziale in acciaio inox satinato AISI 304.

Right or left shower enclosure in 8 mm tempered glass only for shower trays Art. SM_COMBI within a corner complete with wall profile and satin stainless steel AISI 304 bar.

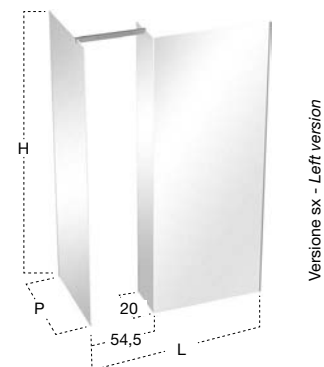

Versione sx - Left version



Vetro extrachiaro
Extra-clear glass

Vetro acidato
Acid glass

Vetro bronzo
Bronze glass

Vetro fumé
Fumé glass

Vetro riflettente fumé
Reflective fumé glass



PIATTI BOX DOCCIA
SHOWER ENCLOSURES

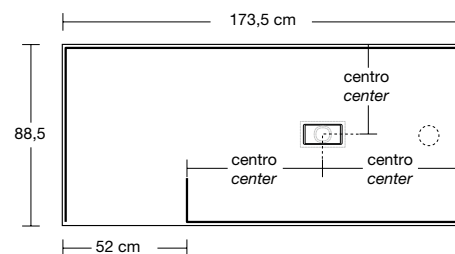

Versione sx - Left version

P	H	L	art.
88,5	2	173,5	SM_ISOLA

Piatto doccia rettangolare dx o sx da appoggio (A), da incasso (B) o da semincasso (*C) in Moodlight spess. 2 cm, completo di sifone e piletta con scarico libero.

Solo per box doccia Art. ISOLA88.

N.B. Su richiesta è possibile realizzare foro per soffione Art. SHAWA2.

Right or left rectangular top mount (A), encased (B) or semi encased (*C) shower tray in Moodlight 2 cm thick, complete with siphon and open drain.

Only for shower enclosures Art. ISOLA88.

P.S. Showerhead hole Art. SHAWA2 upon request.

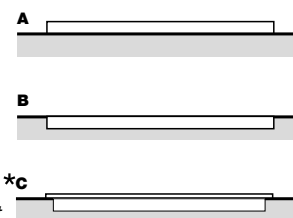

* Lavorazione su richiesta - Manufacturing upon request

P	H	L	art.
86,3	197,5	171,3	ISOLA88

Box doccia dx o sx ad isola in vetro temperato spess. 8 mm solo per piatto doccia Art. SM_ISOLA completo di distanziale in acciaio inox satinato AISI 304.

Right or left freestanding shower enclosure in tempered glass 8 mm thick only for shower trays Art. SM_ISOLA, complete with satin stainless steel AISI 304 bar.

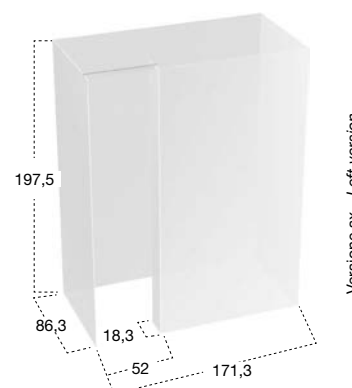

Versione sx - Left version



Vetro extrachiaro
Extra-clear glass

Vetro acidato
Acid glass

Vetro bronzo
Bronze glass

Vetro fumé
Fumé glass

Vetro riflettente fumé
Reflective fumé glass

PENISOLA design Nevio Tellatin



PIATTI BOX DOCCIA
SHOWER ENCLOSURES

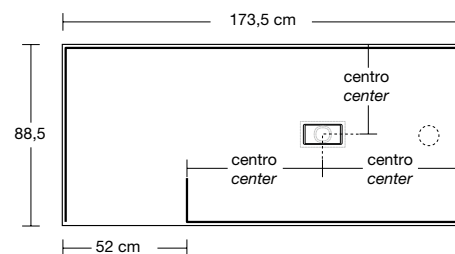

Versione sx - Left version

P	H	L	art.
88,5	2	173,5	SM_PENISOLA

Piatto doccia rettangolare dx o sx da appoggio (A), da incasso (B) o da semincasso (*C) in Moodlight spess. 2 cm, completo di sifone e piletta con scarico libero.

Solo per box doccia Art. PENISOLA88.

N.B. Su richiesta è possibile realizzare foro per soffione Art. SHAWA2.

Right or left rectangular top mount (A), encased (B) or semi encased (*C) shower tray in Moodlight 2 cm thick, complete with siphon and open drain.

Only for shower enclosures Art. PENISOLA88.

P.S. Showerhead hole Art. SHAWA2 upon request.

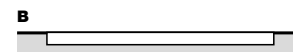

* Lavorazione su richiesta - Manufacturing upon request

P	H	L	art.
86,3	197,5	171,3	PENISOLA88

Box doccia dx o sx a penisola in vetro temperato spess. 8 mm solo per piatto doccia Art. SM_PENISOLA, completo di profili a parete e distanziale in acciaio inox satinato AISI 304.

Right or left shower enclosure in tempered glass 8 mm thick only for shower trays Art. SM_PENISOLA, complete with wall profiles and satin stainless steel AISI 304 bar.

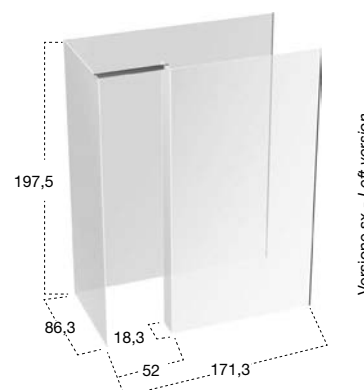

Versione sx - Left version





PIATTE BOX DOCCIA
SHOWER ENCLOSURES

H	P	L	art.
3	70	90	ZEROMATT7090
		100	ZEROMATT70100
		120	ZEROMATT70120
		140	ZEROMATT70140

H	P	L	art.
3	80	80	ZEROMATT8080
		100	ZEROMATT80100
		120	ZEROMATT80120
		140	ZEROMATT80140
		160	ZEROMATT80160

H	P	L	art.
3	90	90	ZEROMATT9090
		100	ZEROMATT90100
		120	ZEROMATT90120
		140	ZEROMATT90140
		160	ZEROMATT90160

H	P	L	art.
3	100	100	ZEROMATT100100
		120	ZEROMATT100120
		140	ZEROMATT100140
		160	ZEROMATT100160

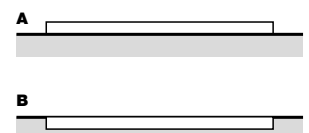
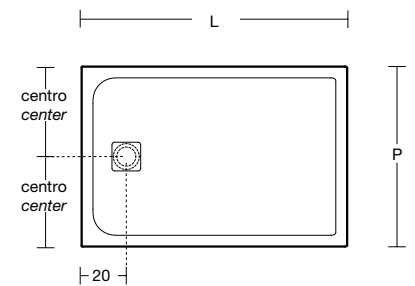
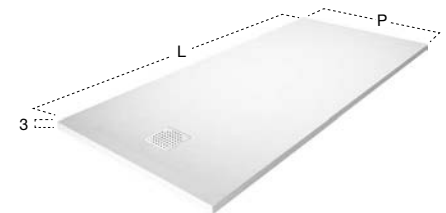

Piatto doccia rettangolare da appoggio (A) o da incasso (B) in Ceramilux in finitura opaca, completo di sifone e piletta con scarico libero.

Rectangular top mount (A) or encased (B) shower tray in Ceramilux in matt finish, complete with siphon and open drain.



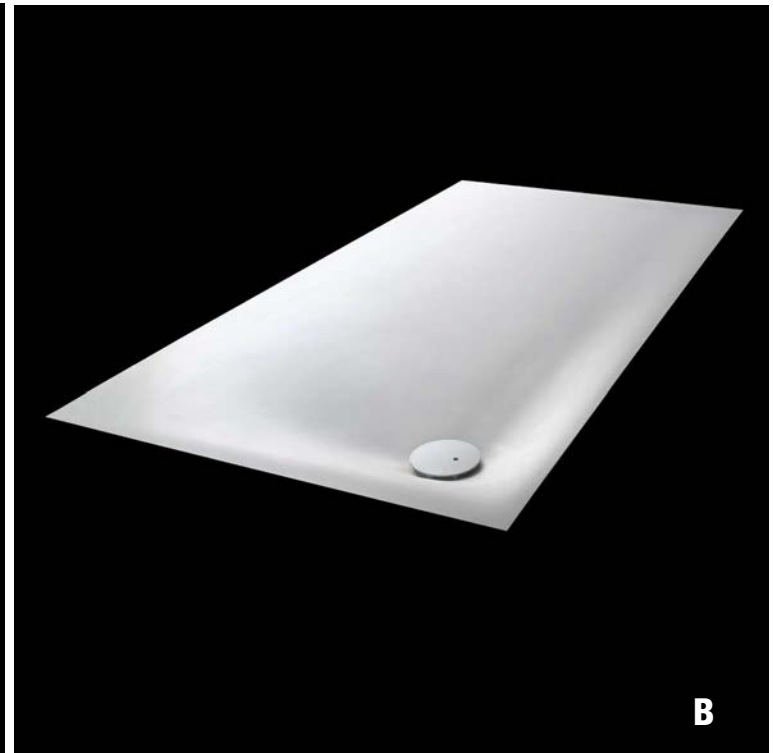

PIATTE BOX DOCCIA
SHOWER ENCLOSURES

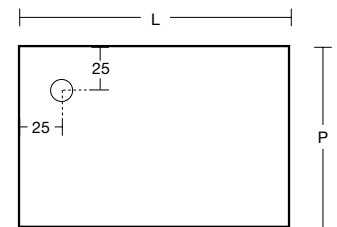
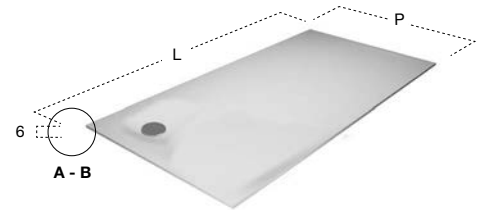

Versione dx - Right version

H	P	L	art.
6	70	90	00_ST1
	80	110	00_ST2
	80	120	00_ST3
	80	140	00_ST4
	90	90	00_ST5
	90	140	00_ST6

Piatto doccia rettangolare dx o sx da appoggio (A) o da incasso (B) termoformato in Corian, con supporto poliuretano completo di sifone e piletta con scarico libero.

Right or left rectangular top mount (A) or encased (B) shower tray completely in Corian with polyurethane support complete with siphon and open drain.

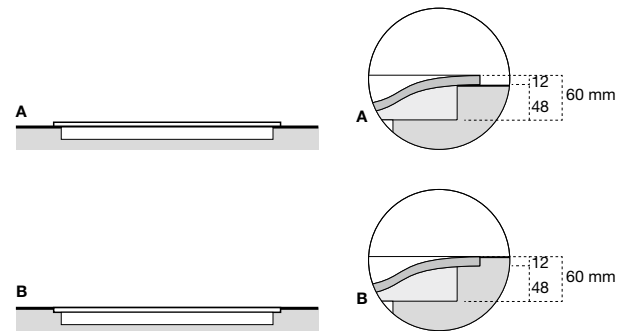





art.	P
00_XL70	70
00_XL80	80
00_XL90	90
00_XL100	100
00_XL110	110
00_XL120	120
00_XL130	130
00_XL140	140

H	L
6	80/90
	91/100
	101/110
	111/120
	121/130
	131/140
	141/150
	151/160
	161/170
	171/180
	181/190 **
	191/200 **
	201/210 **
	211/220 **
	221/230 **
	231/240 **
	241/250 **
	251/260 **
	261/270 **
	271/280 **
	281/290 **
	291/300 **

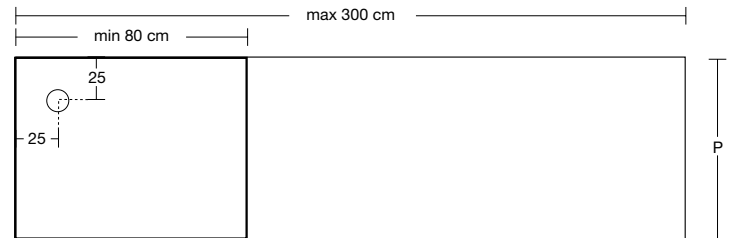
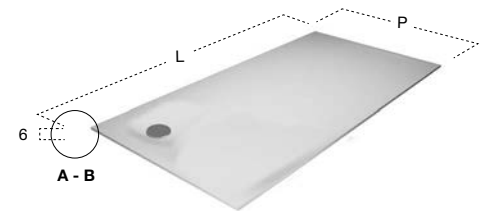

Versione dx - Right version

** N.B. Su richiesta è possibile inserire un secondo scarico completo di piletta sifonata. (La pendenza sarà divisa per due).
P.S. Upon request it is possible to have a second drain complete with trap and plug (the slope will be divided in half).

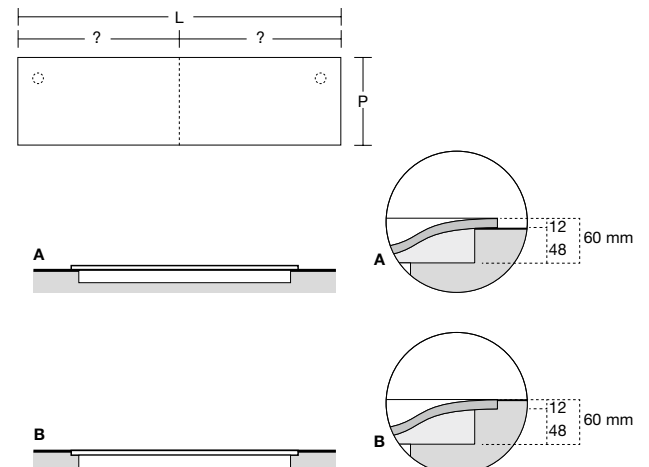

Piatto doccia rettangolare dx o sx a misura, da appoggio (A) o da incasso (B) termoformato in Corian, con supporto poliuretano completo di sifone e piletta con scarico libero.

Right or left rectangular top mount (A) or encased (B) shower tray completely in Corian with polyurethane support complete with siphon and open drain.

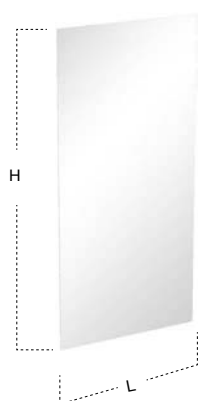

H	L	art.
195	77,5	VB13
	87,5	VB14
	97,5	VB15
	107,5	VB16
	117,5	VB17
220	127,5	VB18
	137,5	VB19
	77,5	VB3
	87,5	VB4
	97,5	VB5
	107,5	VB6
	117,5	VB7
	127,5	VB8
	137,5	VB9

Vetro temperato spess. 8 mm solo per piatti doccia SUMISURA, ZEROMATT, 00_XL e 00_ST.

8 mm tempered glass only for shower trays SUMISURA, ZEROMATT, 00_XL and 00_ST.

Ø	L	art.	Per piatti doccia
			For shower trays
			P
2	64,4	POLE1	70
	74,4	POLE2	80
	84,4	POLE3	90
	94,4	POLE4	100
	104,4	POLE5	110

Asta distanziale per vetri box doccia in acciaio inox satinato AISI 304.

Satin stainless steel AISI 304 shower bar for glass shower.

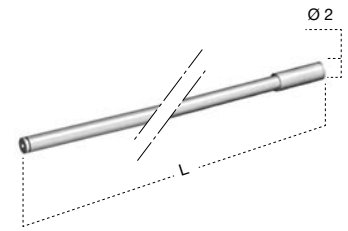

H	P	L	art.
195	2,8	1,8	PEG4
220	2,8	1,8	PEG3

Profilo in acciaio inox satinato AISI 304 per il fissaggio a parete dei vetri box doccia Art. VB.

Glass wall fixing profiles in satin stainless steel AISI 304 for shower glass Art. VB.

PEG design Nevio Tellatin

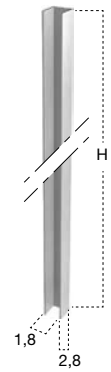

PIATTI BOX DOCCIA
SHOWER ENCLOSURES



vetro extrachiario
extra-clear glass



vetro acidato
acid glass



vetro bronzo
bronze glass



vetro fumé
fumé glass



vetro riflettente fumé
reflective fumé glass